

# RICOH

Digital Camera

## PENTAX XG-1

Operating Manual

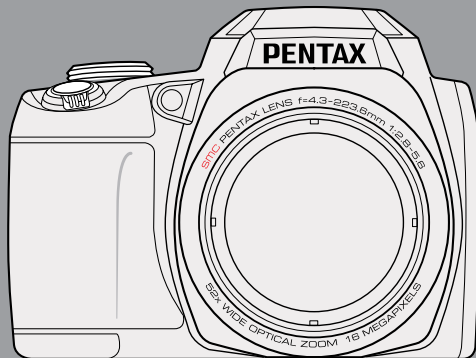

**HDMI**<sup>®</sup>  
HIGH-DEFINITION MULTIMEDIA INTERFACE

To ensure the best performance from your camera, please read the Operating Manual before using the camera.

Thank you for purchasing PENTAX XG-1.

Please read this manual before using the camera in order to get the most out of all the features and functions. Keep this manual safe, as it can be a valuable tool in helping you to understand all the camera's capabilities.

## Regarding copyrights

Images taken using the PENTAX XG-1 that are for anything other than personal enjoyment cannot be used without permission according to the rights as specified in the Copyright Act. Please take care, as there are cases where limitations are placed on taking pictures even for personal enjoyment during demonstrations, performances or of items on display. Images taken with the purpose of obtaining copyrights also cannot be used outside the scope of use of the copyright as laid out in the Copyright Act, and care should be taken here also.

## Regarding trademarks

- SDHC logo is a trademark of SD-3C, LLC.
- Microsoft, Windows and Windows Vista are registered trademarks of Microsoft Corporation in the United States of America and other countries.
- Macintosh and Mac OS are trademarks of Apple Inc., registered in the U.S. and other countries.
- HDMI, the HDMI logo, and High-Definition Multimedia Interface are trademarks or registered trademarks of HDMI Licensing, LLC in the United States and/or other countries.
- Eye-Fi, the Eye-Fi logo, and Eye-Fi *connected* are trademarks of Eye-Fi, Inc.
- Intel, Intel Core, and Pentium are trademarks of Intel Corporation in the U.S. and/or other countries.

- This product is licensed under the AVC Patent Portfolio License for the personal use of a consumer or other uses in which it does not receive remuneration to (i) encode video in compliance with the AVC standard (“AVC video”) and/or (ii) decode AVC video that was encoded by a consumer engaged in a personal activity and/or was obtained from a video provider licensed to provide AVC video. No license is granted or shall be implied for any other use.

Additional information may be obtained from MPEG LA, LLC.

See <http://www.mpegla.com>.

- All other trademarks are the property of their respective owners.
- Throughout this manual, the following symbols are used to help you locate information quickly and easily:



Indicates useful information.

- In introducing you how to operate this camera, the following symbol may appear to facilitate your understanding:

[Item properties] : The optional properties in the camera interface are indicated by the symbol [ ] .

## To users of this camera

- Do not use or store this device in the vicinity of equipment that generates strong electromagnetic radiation or magnetic fields.  
Strong static charges or the magnetic fields produced by equipment such as radio transmitters could interfere with the monitor, damage the stored data, or affect the product's internal circuitry and cause camera misoperation.
- The liquid crystal panel used in the display is manufactured using extremely high precision technology. Although the level of functioning pixels is 99.99% or better, you should be aware that 0.01% or fewer of the pixels may not illuminate or may illuminate when they should not. However, this has no effect on the recorded image.
- There is a possibility that the illustrations and the display screen in this manual are different from the actual product.
- In this manual, the generic term “computer(s)” refers to either a Windows PC or a Macintosh hereafter.
- In this manual, the term “battery(ies)” refers to any type of batteries used for this camera and accessories.



## Using Your Camera Safely

We have paid close attention to the safety of this product. When using this product, we request your special attention regarding items marked with the following symbols.



**Warning**

This symbol indicates that violating this item could cause serious personal injuries.



**Caution**

This symbol indicates that violating this item could cause minor or medium personal injuries, or loss of property.

### About the Camera



**Warning**

- Do not attempt to take the camera apart or modify the camera. High voltages are present within the camera, and there is a danger of electric shock if the camera is taken apart.
- If the inside of the camera should become exposed as a result of, for example, the camera being dropped, please do not under any circumstances touch such exposed portions, as there is a danger of receiving an electric shock.
- Wrapping the strap of the camera around your neck is also dangerous. Please take care that small children do not hang the strap around their necks.
- If any irregularities occur during use, such as smoke or a strange odor, stop use immediately, remove the battery or the power adapter, and contact your nearest service center. Continuing to use the product can cause a fire or electric shock.



**Caution**

- Do not place your finger on the flash when it is discharging as there is a risk of burns.
- Do not discharge the flash while it is touching your clothing as there is a risk of discoloring.

- Some portions of the camera heat up during use, so please take care, as there is a risk of low temperature burns if such portions are held for long periods of time.
- Should the LCD be damaged, be careful of glass fragments. Also, be careful not to allow the liquid crystal to get on your skin, in your eyes, or in your mouth.
- Depending on your individual factors or physical condition, the use of the camera may cause itching, rashes or blisters. In case of any abnormality, stop using the camera and get medical attention immediately.

## About the Power Adapter

### **Warning**

- Always use the power adapter exclusively developed for this product, with the specified power and voltage. Using a power adapter not exclusive to this product, or using the exclusive power adapter with an unspecified power or voltage can cause a fire, electric shock, or camera breakdown. The specified voltage is 100- 240V AC.
- Do not disassemble or modify the product. This can cause a fire or electric shock.
- If the generation of smoke or strange odor from the product or other abnormality occurs, immediately discontinue its use and consult your nearest service center. Continuing to use the product can cause a fire or electric shock.
- If water should happen to get inside the product, consult your nearest service center. Continuing to use the product can cause a fire or electric shock.
- If a thunder storm should occur while using the power adapter, unplug it and discontinue use. Continuing to use the product can cause damage to the equipment, fire, or electric shock.
- Wipe off the plug of the power adapter if it becomes covered with dust. Dust on the plug may cause a fire.

## **Caution**

- Do not place heavy objects on the USB cable, allow heavy objects to drop onto it or allow it to become damaged due to excessive bending. If the USB cable becomes damaged, consult your nearest service center.
- Do not short or touch the output terminals of the product while it is still plugged in.
- Do not plug in the power adapter with wet hands. This can cause an electric shock.
- Do not subject the product to strong impacts or allow it to drop onto a hard surface. This can cause a malfunction.
- Do not use the power adapter to charge a battery other than the rechargeable lithium-ion battery LB-060. This can cause overheating, explosion, or power adapter failure.
- To reduce the risk of hazards, use only a CSA/UL certified power supply cord set, cord is Type SPT-2 or heavier, minimum NO.18 AWG copper, one end with a molded-on male attachment plug cap (with a specified NEMA configuration), and the other is provided with a molded-on female connector body (with a specified IEC nonindustrial type configuration) or the equivalent.

## **About the Battery**

### **Warning**

- Be sure to store the battery out of the reach of small children. Placing it in their mouths may cause an electric shock.
- If any leakage from the battery should come in contact with your eyes, it may cause a loss of sight. Flush your eyes with clean water and get medical attention immediately. Do not rub them.

 **Caution**

- Only use the specified battery with this camera. Use of other batteries may cause an explosion or fire.
- Do not disassemble the battery. Disassembling the battery may cause an explosion or leakage.
- Remove the battery from the camera immediately if it becomes hot or begins to smoke. Be careful not to burn yourself during removal.
- Keep wires, hairpins, and other metal objects away from the + and - contacts of the battery.
- Do not short the battery or dispose of the battery in fire. This can cause an explosion or fire.
- If any leakage from the battery should come in contact with skin or clothes, it may cause irritation to the skin. Wash the affected areas thoroughly with water.
- Precautions for LB-060 Battery Usage:
  - This battery may present a fire or chemical burn hazard if mistreated.
  - **WARNING** - Risk of fire, burns and explosion. Do not short, open, disassemble, crush, incinerate or expose to heat above 140°F/60°C.
  - Recharge according to user manual.
  - Dispose of used battery properly.

**Keep the Camera and Accessories Out of the Reach of Small Children** **Warning**

- Be sure to keep the camera and its accessories out of the reach of small children.
  1. Injuries may result from the product falling or from unexpected movement.
  2. Suffocation may result from wrapping the strap around the neck.
  3. Small accessories such as battery or an SD Memory Card may be swallowed. Seek medical attention immediately if an accessory is accidentally swallowed.

## Care to be Taken During Handling

### **Before Starting Use**

- When the camera has not been used for a long time, confirm that it is still working properly, particularly prior to taking important pictures (such as at a wedding or when traveling). Contents of the recording cannot be guaranteed if recording, playback or transferring your data to a computer, etc. is not possible due to a malfunction of your camera or recording media (SD Memory Card), etc.
- The lens on this camera is not interchangeable. The lens is not removable.

### **About the Battery and Power Adapter**

- Storing the battery fully charged may decrease the battery performance. Avoid storing it especially in high temperatures.
- If the battery is left inserted and the camera is not used for a long time, the battery will over-discharge and shorten the battery's service life.
- Charging the battery a day before use or on the day of use is recommended.
- The power adapter supplied with the camera is for exclusive use with this camera. Do not use it with any other equipment.

## Cautions when Carrying and Using the Camera

- Do not use or store the camera in a hot environment or under direct sunlight.
- Hot and humid places should be avoided. Particular care should be taken regarding vehicles, which can become very hot inside.
- The temperature range in which the camera can be used is 0°C to 40°C (32°F to 104°F).
- The liquid crystal display will become black at high temperatures but will return to normal at normal temperatures.
- The response speed of the liquid crystal display becomes slow at low temperatures. This is due to the properties of the liquid crystal and is not a malfunction.
- If the camera is subjected to rapid temperature changes, condensation may form on the inside and outside of the camera. Therefore put the camera in a bag or plastic bag and take the camera out when the difference in temperature has subsided.
- Avoid contact with garbage, mud, sand, dust, water, toxic gases, or salts. These could cause the camera to breakdown. Wipe the camera to dry off any rain or water drops.
- Please do not press forcefully on the display. This could cause it to break or malfunction.
- When using a tripod with the camera, be careful not to overtighten the screw in the tripod socket on the camera.

## About Repairs

- Do not clean the product with organic solvents such as thinner, alcohol or benzene.
- Use a lens brush to remove dust accumulated on the lens. Never use a spray blower for cleaning as it may damage the lens.

## About Storage

- Avoid storing the camera where pesticides and chemicals are handled. Remove the camera from its case and store it in a well-ventilated place to prevent the camera from becoming moldy during storage.
- Avoid using or storing the camera where it may be exposed to static electricity or electrical interference.
- Avoid using or storing the camera in direct sunlight or in locations where it may be exposed to rapid changes in temperature or to condensation.
- Periodic checks are recommended every 1 to 2 years in order to maintain high performance.

## Others

- The SD Memory Card is equipped with a write-protect switch. Setting the switch to LOCK prevents new data from being recorded on the card, the stored data from being deleted, and the card from being formatted by the camera or computer.
- Care should be taken when removing the SD Memory Card immediately after using the camera, as the card may be hot.
- Keep the battery/card cover closed and do not remove the SD Memory Card or turn the camera off while the data is being played back or saved to the card, or the camera is connected to a computer with the USB cable, as this may cause the data to be lost or the card to be damaged.

- Do not bend the SD Memory Card or subject it to violent impact. Keep it away from water and store away from high temperature.
- Do not remove the SD Memory Card during formatting as this may damage the card and render it unusable.
- The data on the SD Memory Card may be lost in the following circumstances. We do not accept any liability for data that is deleted
  1. when the SD Memory Card is mishandled by the user.
  2. when the SD Memory Card is exposed to static electricity or electrical interference.
  3. when the SD Memory Card has not been used for a long time.
  4. when the SD Memory Card is ejected or the batteries are removed while the card is being accessed.
- If it is not used for a long time, the data on the card may become unreadable. Be sure to regularly make a backup of important data on a computer.
- Be sure to format SD Memory Cards that are unused or have been used on another camera.
- Please note that deleting data, or formatting the SD Memory Cards or the built-in memory does not completely erase the original data. Deleted files can sometimes be recovered using commercially available software. It is user's responsibility to ensure the privacy of such data.



# CONTENTS

CONTENTS.....	12	MODE OVERVIEW .....	27
GETTING READY .....	16	LCD Screen Display.....	27
Accessories Included .....	16	Overview of the Screen Icons in Photo Shooting Mode .....	27
Install lens cap and neck strap.....	17	Overview of the Screen Icons in Movie Mode .....	29
Part Names .....	18	Using the Mode Dial.....	30
Installing Battery and Memory Card....	20	Auto Mode .....	31
Charging Battery .....	22	Program AE .....	33
Turning Camera On and Off.....	24	Shutter Priority .....	33
How to take pictures.....	24	Aperture Priority .....	34
Set your Language, Date/Time .....	25	Manual Mode .....	34
Set your Language, Date/Time after the first power-on.....	25	Face Beautifier .....	35
Resetting your Language.....	25	Scene Mode .....	36
Resetting Date/Time .....	26	Custom Settings.....	38

<b>BASIC OPERATION</b> .....	<b>40</b>	<b>PLAYBACK</b> .....	<b>52</b>
Using EVF (Electronic View Finder)....	40	Overview of the Screen Icons in Playback Mode.....	52
Using the Zoom Function.....	40	Viewing Photos and Videos .....	53
Focus Setting .....	41	Thumbnail View.....	54
Macro Mode .....	42	Using Zoom Playback (for still pictures only).....	55
Self-Timer Setting .....	43	Photos and Video Deletion.....	56
Flash Mode .....	44	Slideshow.....	57
White Balance Setting.....	45	Continuous Capture Group Playback.....	58
Display Setting .....	46		
Drive Mode.....	47		
EV Setting .....	48		
Exposure Compensation .....	48		
ISO.....	49		
Shutter Adjustment .....	49		
Aperture Adjustment .....	50		
Using Quick Recording .....	50		
i Button Function Menu .....	51		
		<b>USING THE MENUS</b> .....	<b>59</b>
		Photo Shooting Menu.....	59
		Expo Metering (Exposure Metering) .....	59
		Image Size.....	60
		OIS.....	61

Cont. AF.....	61	Digital Zoom.....	70
HDR.....	62	Playback Menu.....	71
Beauty.....	62	Playback .....	71
Scene.....	63	HDR .....	72
Photo Shooting Setting Menu .....	64	Touch-up.....	73
Quality.....	64	Rotate .....	74
AF-Assist Beam .....	65	Resize.....	75
Digital Zoom.....	65	i Button Playback Function.....	76
Date Imprint .....	65	Playback Setting Menu .....	77
Quick Review.....	66	Protect .....	78
Custom Settings .....	66	Delete .....	79
Movie Menu.....	67	Trim.....	80
Expo Metering (Exposure Metering) .....	67	Setup Menu.....	81
Video Quality .....	68	Sound Settings .....	82
OIS.....	69	Power Saver .....	82
Movie Setting Menu .....	69	Language.....	83
Custom Settings .....	70	World Time.....	83
		Date/Time .....	83

LCD Brightness.....	83
File / Software .....	84
Format Memory .....	84
Copy to Card.....	85
File Numbering .....	85
Reset .....	86
FW Version .....	86

## CONNECTIONS ..... 87

Connecting to a Computer .....	87
Transferring files to your computer.....	87
Video System .....	88
Set Eye-Fi Card Connection Mode .....	89
Supported HDMI Connections .....	90
Connecting to an HDMI-Ready TV .....	90

## APPENDICES ..... 91

Main Specifications .....	91
Prompts and Warning Messages .....	97
Troubleshooting .....	101
Warranty Policy .....	103

# GETTING READY

## Accessories Included

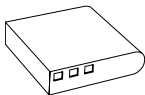

Rechargeable  
lithium-ion battery  
LB-060

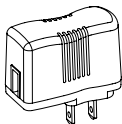

Power adapter  
GAC-03

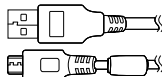

USB cable  
I-USB152



Strap  
O-ST152

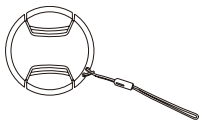

Lens cap  
O-LC152



Quick start guide

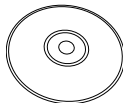

Operating Manual  
CD-ROM



The plug shape of the power adapter may vary depending on the country or region. The actual item may vary from the drawing.

## Install lens cap and neck strap

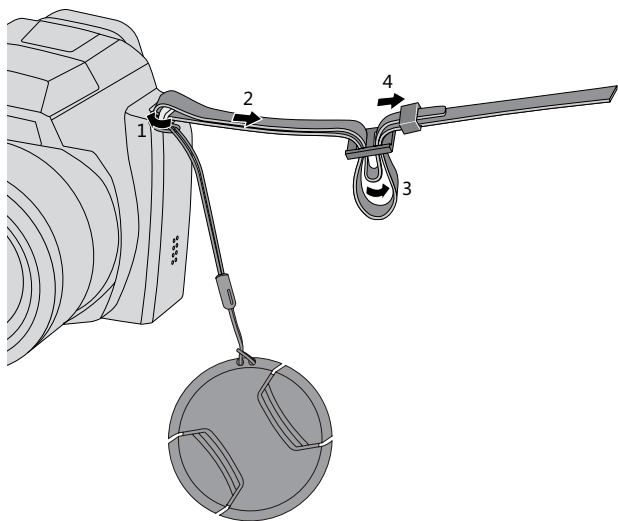

## Part Names

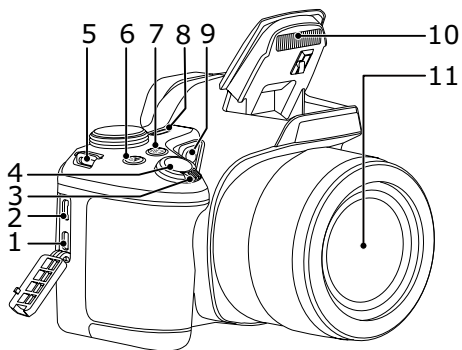

- 1 HDMI Port
- 2 USB/AV Port
- 3 Zoom Lever
- 4 Shutter Button
- 5 Strap Eyelet
- 6 Exposure Compensation Button
- 7 Continuous Capture Button
- 8 Power Button
- 9 AF Assist Beam/Self-timer Lamp
- 10 Flash Lamp
- 11 Lens

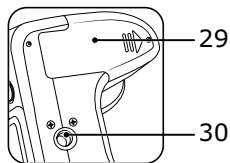
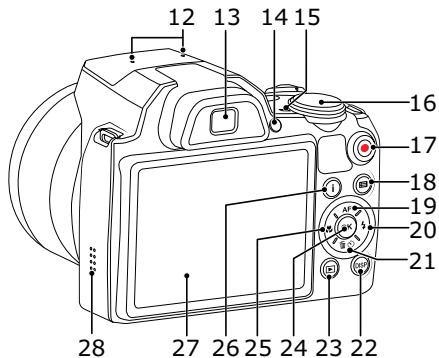

- 12 Microphone
- 13 Electronic View Finder (EVF)
- 14 EVF Button
- 15 Status Indicator
- 16 Mode Dial
- 17 Fast Video Recording Button
- 18 Menu Button
- 19 AF Button/Arrow Button (Up)
- 20 Flash Button/Arrow Button (Right)
- 21 Delete Button/Self-timer Button/Arrow Button (Down)
- 22 Display Button
- 23 Playback Button
- 24 OK Button
- 25 Macro Button/Arrow Button (Left)
- 26 i Button
- 27 LCD Screen
- 28 Speaker
- 29 Battery Cover
- 30 Tripod Receptacle



## Installing Battery and Memory Card

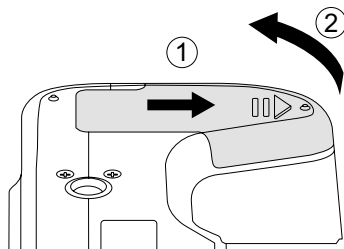

1. Open the battery cover.

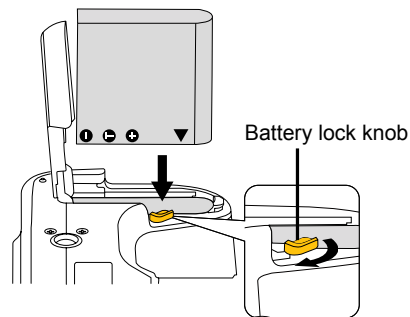

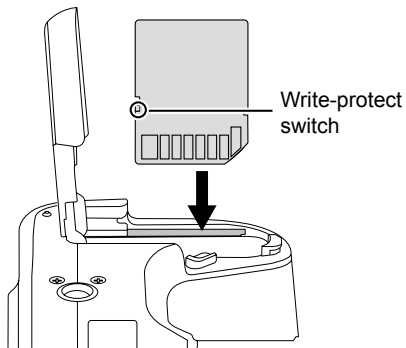

2. Insert the battery into the battery slot in the correct position as shown in the following diagram.

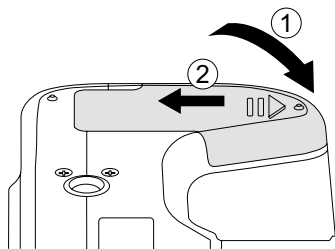

3. Insert the SD memory card into the memory card slot as shown in the diagram below.



4. Close the battery cover.

-  The memory card (SD/SDHC) is optional and not included in all camera packaging. Purchase a commercially available one.
-  To remove your SD memory card, open the battery cover, gently press the memory card to eject it and remove it.

## Charging Battery

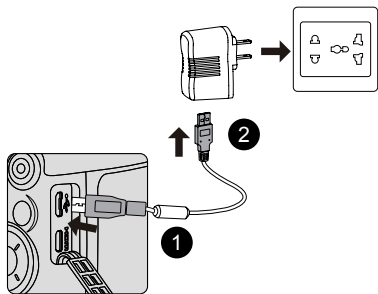



Before charging the battery, ensure that the battery is inserted properly and the camera is off.

1. Connect the camera and the power adapter using the supplied USB cable.
2. Insert the plug of the power adapter into the wall outlet to charge the battery.

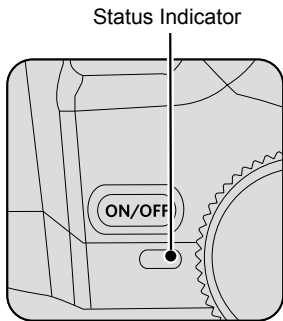

After the battery is stored for a long period of time, use the supplied power adapter to charge the battery prior to use.



-  **Charging indicator:**  
Flashing red: Charging  
The indicator will go out once charging is finished, and the camera will be powered off automatically.  
To have maximum battery life, charge the battery for at least 4 hours at the first time.
-  The time required to fully charge the battery is about 360 minutes (max.). (The charging time may vary depending on the ambient temperature and charging conditions.) The appropriate ambient temperature for charging the battery is 0°C to 40°C (32°F to 104°F).

## Turning Camera On and Off

Press the power button to turn the camera on. To turn the camera off, press the power button again.

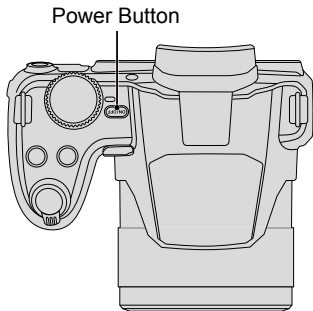

Press and hold the playback button to power on and enter playback mode.

## How to take pictures

1. Hold the camera firmly.
2. Make the lens focus on the object and then frame with the LCD screen. (Use the zoom lever to zoom in or out on the object)
3. Press the shutter button half way to focus. When the focus frame turns green, fully press the shutter button to complete shooting.

## Set your Language, Date/Time

### Set your Language, Date/Time after the first power-on

1. When you turn the camera on for the first time, the language selection screen appears.
2. Press the arrow buttons to select your desired language.
3. After you press the **OK** button to confirm the selection, the Date/Time settings screen appears.
4. Press the left/right arrow button to select the Date/Time to be adjusted: Time is displayed in yyyy : MM : dd HH : mm.
5. Press the up/down arrow button to adjust the value for the selected Date/Time.
6. Press the **OK** button to confirm the time settings.

### Resetting your Language

After you set your language for the first time, follow the instructions below to reset your language.

1. Press the power button to turn the camera on.
2. Press the **Menu** button, press the up/down arrow button to select **Menu**, and press the **OK** button to enter the menu.
3. Press the up/down arrow button to select **Language**, and press the **OK** button or right arrow button to enter the menu.
4. Press the up/down arrow button to select **[Language]** and press the **OK** button or right arrow button to enter the menu.
5. Press the arrow buttons to select your desired language and press the **OK** button to confirm.
6. Press the **Menu** button and the shooting screen appears.





- Press the left/right arrow button to select the Date/Time to be adjusted: Time is displayed in yyyy : MM : dd HH :mm.
- Press the up/down arrow button to press the value for your selected block. After you finish your settings, press the **OK** button to confirm.
- Press the **Menu** button and the shooting screen appears.

## Resetting Date/Time

After you set your Date/Time for the first time, follow the instructions below to reset date and time.

- Press the power button to turn the camera on.
- Press the **Menu** button, press the up/down arrow button to select **Language**, and press the **OK** button to enter the menu.
- Press the up/down arrow button to select **World Time**, and press the **OK** button or right arrow button to enter the menu.
- Press the up/down arrow button to select [Date & Time] and press the **OK** button or right arrow button to enter the menu.

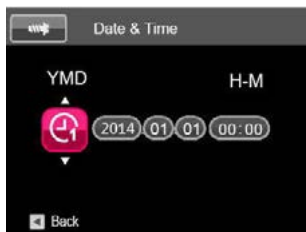
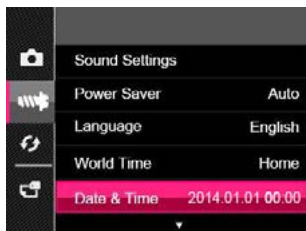

# MODE OVERVIEW

## LCD Screen Display

### Overview of the Screen Icons in Photo Shooting Mode

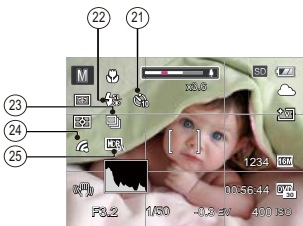
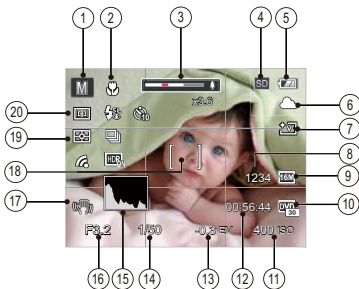

### 1 Shooting Mode Icons

- AUTO** Auto Mode Face Beautifier
- P** Program AE Handheld Night
- Tv** Shutter priority **SCN** Scene Mode
- Av** Aperture priority **CS** Custom Settings
- M** Manual Mode

### 2 Macro Mode

3 Zoom Display  
(By turning the Zoom Lever)

### 4 SD Memory Card/Built-in Memory

### 5 Battery Status







6 White Balance  
(Adjustable in **P Tv Av M** Mode)

7 Color Effect  
(Adjustable in **P Tv Av M** Mode)

8 Number of remaining shots







9 Image Size







- 10 Video Quality
- 11 ISO Value  
(Adjustable in **P Tv Av M** Mode)
- 12 Remaining Recording time
- 13 Exposure Compensation (EV value)  
(Adjustable in **P Tv Av** Mode)
- 14 Shutter Speed  
(Adjustable in **Tv M** Mode)
- 15 Histogram
- 16 Aperture Value  
(Adjustable in **Av M** Mode)
- 17 Image stabilization
- 18 Focus Frame
- 19 Expo Metering
-  AiAE
-  Spot
-  Center
- 20 AF Mode
-  Single-AF
-  Multi-AF
-  Object Tracking
- 21 Self-Timer

-  Self-timer Off
-  Self-timer 2sec
-  Self-timer 10sec
-  Self-timer Smile

22 Flash Mode

-  Force Off
-  Flash Auto
-  Force Flash
-  Slow Sync.
-  Slow Sync. + Red-Eye
-  Red-Eye Reduction

23 Drive Mode



-  Single
-  Continuous Shot
-  Cont. Shot- High Speed (VGA)
-  Cont. Shot-Fast (4M)
-  Time-Lapse (30sec/ 1min/ 5min/ 10min)

24 Eye-Fi ON

25 HDR (Adjustable in **P Tv Av M** Mode)

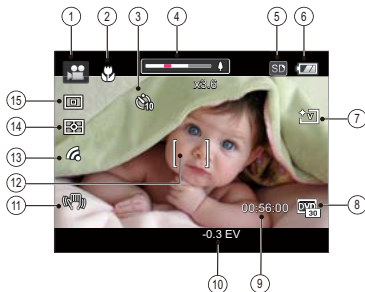
## Overview of the Screen Icons in Movie Mode



- 1 Movie Mode
- 2 Macro Mode
- 3 Self-Timer
  -  Self-timer Off
  -  Self-timer 10sec
- 4 Zoom Display (by turning the Zoom Lever)
- 5 SD Memory Card/Built-in Memory
- 6 Battery Status

- 7 Color Effect
- 8 Video Quality
- 9 Remaining Recording time
- 10 Exposure Compensation (EV value)
- 11 Image stabilization
- 12 Focus Frame
- 13 Eye-Fi ON
- 14 Expo Metering



AiAE



Spot



Center

- 15 AF Mode





Use an SD memory card with Class 4 or higher for the video recording.



Optical Zoom and Digital Zoom can be adjusted (208X in total). Digital Zoom can be adjusted to 4X.

## Using the Mode Dial

This camera provides a convenient mode dial that allows you to manually switch between different modes with ease. The available modes are listed below:

Mode Name	Icon	Description
Auto Mode	<b>AUTO</b>	In this mode, the optimal conditions for taking pictures will be set based on the subject and environment. It is the most commonly used mode for taking pictures.
Program AE	<b>P</b>	Under different scenes, the user can switch the ISO and EV value according to personal preference, the camera can automatically set the shutter speed and aperture value.
Shutter priority	<b>Tv</b>	Setting allows you to choose a specific shutter speed so the camera will adjust the aperture automatically to ensure correct exposure.
Aperture priority	<b>Av</b>	Allows you to choose a specific aperture and the camera will automatically adjust the shutter speed to match it.
Manual Mode	<b>M</b>	Many of the camera settings can be configured manually in this mode.
Face Beautifier		This mode automatically enhances facial features with skin softening touches and eye brightening capabilities.
Handheld Night		Clear night pictures also can be taken easily without a tripod.
Scene Mode	<b>SCN</b>	Choose from 11 different pre-set scene types and effects for your photos.
Movie Mode		Records videos.
Custom Settings	<b>CS</b>	The user can store the frequently used shooting modes and parameters and switch to this mode for quick adjustment.





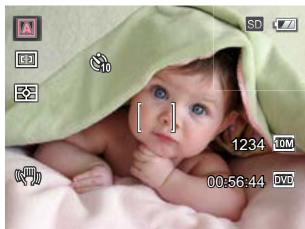

## Auto Mode **AUTO**

Auto Mode is the easiest mode to take photos. While operating in this mode, the camera automatically optimizes numerous camera settings to adjust your photos for the best possible results.

Follow these steps:

1. Turn the Mode Dial to **AUTO** .
2. Hold the camera steadily and aim at the subject. The optimum scene mode will be selected automatically.
3. Press the shutter button half-way down to focus. The LCD screen will show a green focus frame when the subject is in focus.
4. Press the shutter button all the way down to take pictures.





Mode Name	Description
 Landscape Mode	For landscapes, will automatically adjust the exposure and reproduce vivid green and blue colors.
 Portrait Mode	Most suitable for capturing people with focus on their faces.
 Night Portrait	When you take portraits at night, or in low light conditions, will automatically adjust the exposure for people and night scenes.
 Backlit Portrait	When the sun or any other light source is behind the subject, will automatically adjust the foreground exposure to produce the best pictures possible.
 Macro Mode	To produce more detailed close-ups, will automatically engage the camera's Macro Mode and automatically focus the lens.
 Auto Mode	The camera will automatically adjust the exposure and focus to ensure the best possible pictures.

## Program AE **P**

When **P** (Program AE) mode is selected, you can adjust the EV value and ISO value.

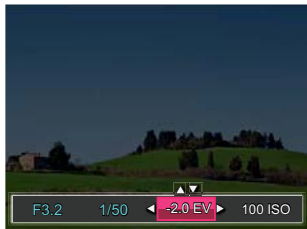
1. Turn the mode dial to **P** and press the  button to configure settings.





2. Press the left/right arrow button to select an adjustment item.
3. Press the up/down button to adjust the parameters.
4. Press the  button to engage the settings and enter the shooting screen.

## Shutter Priority **Tv**

When **Tv** (Shutter Priority) is selected, you can adjust the shutter speed / EV value and ISO value. The camera automatically sets the aperture value based on the shutter speed and ISO value to get the most appropriate exposure value.

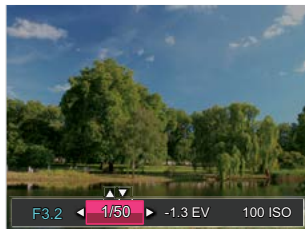
1. Turn the mode dial to **Tv** and press the  button to configure settings.





2. Press the left/right arrow button to select an adjustment item.
3. Press the up/down button to adjust the parameters.
4. Press the  button to confirm the settings and enter the shooting screen.

## Aperture Priority **Av**

When selecting **Av** (Aperture Priority) mode, you can adjust the aperture value / EV value and ISO value. Selecting a large aperture opening will emphasize the point of focus and show a blurry background and foreground. A small aperture opening will keep both the background and main object in clear focus.

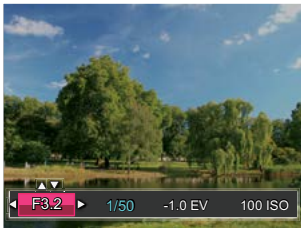
1. Turn the mode dial to **Av** and press the  button to configure settings.





2. Press the left/right arrow button to select an adjustment setting.
3. Press the up/down button to adjust the parameters.
4. Press the  button to confirm the settings and enter the shooting screen.

## Manual Mode **M**

When selecting **M** (manual) mode, you can set the aperture / shutter speed manually and ISO value.

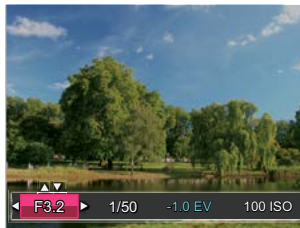



1. Turn the mode dial to **M** and press the  button to configure settings.





2. Press the left/right arrow button to select an adjustment setting.
3. Press the up/down button to adjust the parameters.
4. Press the  button to confirm the settings and enter the shooting screen.

## Face Beautifier

In face beautifier mode, the camera is set to automatically adjust camera exposure for realistic portrayal of skin tones.

1. Turn the mode dial to select face beautifier mode (  ).
2. Press the  button and press the up/down button to select  .
3. Press the left/right arrow button to select Face Beautifier and press the  button to confirm and return to photo shooting mode.

Face beautifier mode has 3 effects:



-  <sub>1</sub> Effect 1: Skin Soften
-  <sub>2</sub> Effect 2: Skin Soften + Eye Brightening
-  <sub>3</sub> Effect 3: Skin Soften + Eye Brightening + Eye Enlargement





## Handheld Night

Reduces blur when shooting low light/illuminated scenes.

-  Quickly takes 4 photos below 8M (including 8M) and then overlaps as a clear night image.
-  Smile shutter cannot be used under this mode.







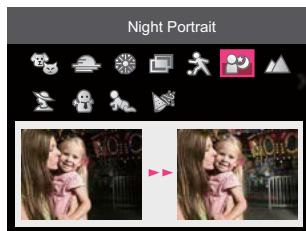



## Scene Mode **SCN**

You can select an appropriate mode from the 11 scene modes according to the type of environment you are shooting. The camera then configures the most appropriate settings automatically.

Turn the Mode Dial to the Scene Mode to enter the Scene Mode menu. The LCD will display a menu like the following example:



Press the arrow buttons to select a scene, and press the  button to confirm.

Scene	Description
 Pet Mode	Rapidly identifies pet (dog/cat) to capture the dynamic moment of pet.
 Sunset	For sunsets. Captures subjects in strong sunlight.
 Fireworks	For fireworks at night. The use of a tripod is recommended.
 Multi Exposure	Suitable for shooting moving objects (as many as 6) in the same background.
 Sport	For fast-moving subjects. Captures sharp, action shots with minimal blur. This mode is not recommended for shooting indoors.
 Night Portrait	For portraits against night scenery.
 Landscape	For landscapes and outdoor shots. Vivid reproduction of green and blue.
 Portrait	Most suitable for capturing people with focus on their face.
 Snow	For snow scenes. Reproduces natural, clear white scenes.
 Children	Turns off flash automatically. Suitable for taking photos of children.
 Party	Suitable for taking indoor party pictures, even under the complicated lighting conditions.

**\* Multi Exposure:**

- Keep camera steady before shooting. Press and hold the shutter button to take 6 photos continuously when it will stop automatically. To stop shooting, release the shutter button in the midway.
- Shooting effect will be influenced if object is moving too fast or too close.

## Custom Settings CS

The user can store the frequently used shooting modes and parameters and switch to this mode for quick adjustment.

### Settings under CS mode (unset state or state after reset):

1. Turn the mode dial to select **CS** mode, and enter the setup screen.



2. As shown in the above example, press the left / right arrow buttons to select a scene, and press the **OK** button to enter the shooting screen.
3. As shown in the following example, press the **Menu** button, and choose whether to continue the **CS** mode setting.

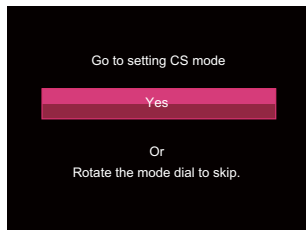

### For setting under other modes (use this method to select a different custom setting):

1. Select any mode or scene mode to be stored.
2. Set your desired parameters in the current mode.
3. Press the **Menu** button, press the up/down arrow button to select **CS**, and press the **OK** button to enter the menu.
4. Press up/down arrow button to select **CS**, and press the **OK** button or right arrow button to enter the menu.

5. Press the down arrow button to select [Custom Settings] and press the  button or the right arrow button to enter the menu.

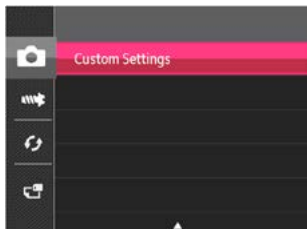

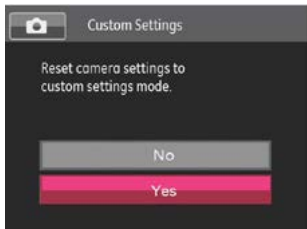

6. Select [Yes] to save or [No] to cancel.



7. Turn the mode dial to switch to the custom settings ( **CS** ).
8. The photo settings you stored the last time are invoked.

 When the **CS** mode is used for the first time, there is no preset parameter stored in the **CS** mode.

 Under the **CS** mode, if you need to retain or modify the set parameters (except the parameters in ) in restart or all modes. Please enter the [Custom Settings] menu and select [Yes] after setup. Otherwise, the parameter settings are not retained in the case of switching on/off or mode switching.

 If you want to remove the parameter setting of [Custom Settings] , please see the reset function on page 86 to operate.

# BASIC OPERATION



## Using EVF (Electronic View Finder)

EVF functions as the LCD screen, which can be used to observe the scene and objects and for playback, preview and menu operations.

EVF has the following advantages:

- It will not be affected by ambient light and may avoid poor composition due to light reflection on the LCD screen.

Follow the steps below:

1. Turn the camera on and press the  button to switch to the EVF display. At this time, the LCD screen will become black.
2. View the scenes and objects through the EVF.
3. Press the  button again or restart the camera to switch back to the LCD screen display.

## Using the Zoom Function

Your camera is equipped with two types of zoom functions: Optical zoom and digital zoom. Toggle the zoom lever of the camera to zoom in or out of the subject while taking pictures.

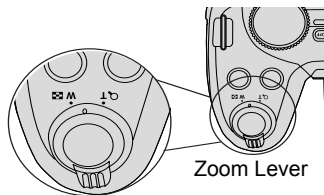

When the optical zoom reaches the threshold as digital zoom, release and turn the zoom lever to  to switch to the digital zoom.



## Focus Setting

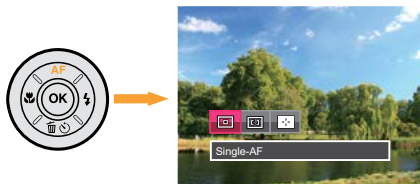

In different photo shooting modes, you can select different focus methods.

1. Press the up arrow button ( **AF** ) to display the settings screen.



2. Press left/right to select any one of the following 3 modes:

-  Single-AF  
The focus frame appears on the center of the LCD screen to focus on the subject.
-  Multi-AF  
The camera automatically focuses the subject in a wide area to find the focus point.

-  Object Tracking  
Smart tracking of the object in motion under the focusing shooting.
3. Press the  button to confirm the settings and exit the menu.
-  Once enabled, Object Tracking will only work when the camera focuses on the object.



## Macro Mode

The Macro Setting is ideal for shooting small objects or close-up photos. This mode allows you to focus on subjects very close to the camera.

1. Press the left arrow button (  ) to enter the Macro Menu.





2. Press left/right to select any one of the following 2 modes:

-  Macro Off  
Select this option to disable Macro.
  -  Macro On  
Select this option to make focusing on the object closer to the lens (At the W side, the shooting distance should be more than 1 cm).
3. Press the  button to confirm the settings and exit the menu.



## Self-Timer Setting

Using this function can take photos at regular time. The camera can be set to shoot after 2 seconds, 10 seconds since pressing the shutter or shoot after smile.

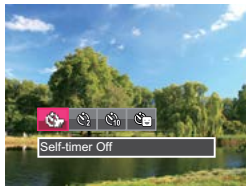
1. Press the down arrow button (   ) to enter the self-timer menu.





2. Press left/right to select any one of the following 4 modes:



-  Self-Timer - Off  
Disables the Self-Timer.
-  Self-Timer - 2 sec  
A single picture is shot 2 seconds after the Shutter Button is pressed.

-  Self-timer - 10 sec  
A single picture is shot 10 seconds after the Shutter Button is pressed.

-  Self-timer - Smile  
Press the Shutter Button and a picture will be taken immediately after a smile is detected.

3. Press the  button to confirm the settings and exit the menu.

-  When enabling the self-timer, pressing the Shutter Button or Down Arrow Button can disable the self-timer and return to the shooting screen, and keep the self-timer setting.

-  When enabling the smile detection, pressing the Shutter Button or  button can disable the self-timer without keeping the self-timer - smile setting.





## Flash Mode



The flash is mainly for supplementing light for the scene. The flash is usually used in shooting against the light to highlight the object shot through lightening the object while darkening the background; it is also suitable for metering and shooting in darker scenes through exposure.



1. Press the right arrow button (  ) to enter the Flash Settings Menu.



2. Press left/right to select any one of the following 6 modes:

-  Force Off  
Flash is turned off.
-  Flash Auto  
Camera flash goes discharges automatically based on existing light conditions.

-  Force Flash  
The flash will engage with each shot even if there is enough available light to take the photo without flash.
-  Slow Sync.  
This allows you to take pictures of people at night that clearly show both your subjects and the night time backdrop. The use of a tripod is recommended when shooting with this setting.
-  Slow Sync. + Red-Eye  
Use this mode for slow synchrony shots with red-eye reduction.

-  Red-Eye Reduction  
The camera emits a brief pre-flash before the picture is taken to reduce red-eye effects.
3. Press the  button to confirm the settings and exit the menu.
-  After pressing the Shutter Button to make focusing, if the photometric value is less, the flash lamp on the top will bounce automatically.

## White Balance Setting







The white balance function allows adjustment of the color temperature for different light sources. (Adjustable in **P Tv Av M** Mode)

Follow the steps below to set white balance of the camera:

1. Press the **OK** button to enter White Balance Menu.



2. Press left/right to select any one of the following 8 modes:

-  AWB
-  Daylight
-  Cloudy
-  Fluorescent (Neutral white)
-  Fluorescent CWF (White light)
-  Incandescent
-  Manual WB (Fully press the shutter button to detect the white balance value)
- **[K]** Color Temp. (1900K~10000K)  
Press the up arrow button, then up/down arrow button to adjust the value. Press the left arrow button to exit the value.

3. Press the **OK** button to confirm the settings and exit the menu.

## Display Setting

Press the **DISP** button to display the settings: Classic, Full, Off.

**Classic:** Displays the camera parameters on screen.



**Off:** Does not display any additional icons on screen.



**Full:** Camera parameters with Grid and Histogram.





## Drive Mode

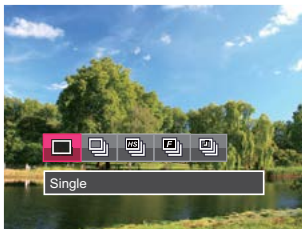

Follow the steps below to configure the Continuous Shot Settings. (Adjustable in **P Tv Av M** Mode)

1. Press the  button to enter the Continuous Shot Menu.



2. Press left/right to select any one of the following 5 modes:

-  **Single**  
Captures a single shot only.
-  **Continuous Shot**  
Continuously shoots up to 9 pictures per second.

-  **Cont. Shot-High Speed (VGA)**  
Continuously shoots up to 60 pictures per second.
-  **Cont. Shot-Fast (4M)**  
Continuously shoots up to 30 pictures per second.
-  **Time-Lapse**  
Take pictures based on the preset interval (30sec/ 1min/ 5min/ 10min).

3. Press the  button to confirm the settings and exit the menu.
4. Press the shutter button to start continuous shooting.

-  The flash is disabled in this mode in order to achieve quick succession of shots.

## EV Setting

The EV function menu of the camera includes functions, such as exposure value, ISO, shutter adjustment and aperture adjustment.

To select the best setting for optimum photos, follow these steps:

1. Press the  button to display the settings screen.
2. Press the left/right arrow button to select the setting option.

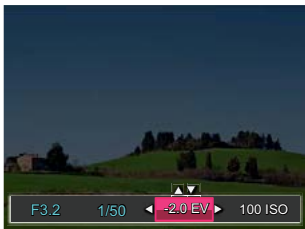

3. Press the up/down button to adjust the option values.
4. Press the  button to complete the setting and enter shooting mode.

## Exposure Compensation

Set up to adjust the picture brightness. In the case of a very high contrast between the photographed object and the background, the brightness of the picture can be appropriately adjusted. (Adjustable in **P Tv Av**  Mode)

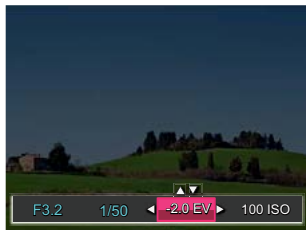

The adjustable range of exposure value is from EV -3.0 to EV+3.0.

## ISO

The ISO function allows you to set the sensitivity of the camera's light sensor based on the brightness of the scene. To improve the camera's sensor performance in darker environments, a higher ISO value is required. A lower ISO value is needed when shooting in brighter conditions.

Pictures taken at higher ISO settings will generally have more noise than those taken at lower ISO settings. (Adjustable in **P Tv Av M** Mode)

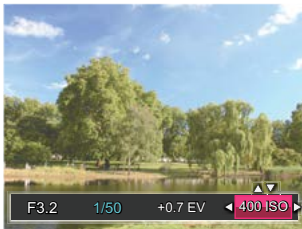

The camera's ISO settings include: automatic, 100, 200, 400, 800, 1600 and 3200.

## Shutter Adjustment

For shutter speed, the camera may automatically set the aperture value corresponding to the manually set shutter speed so as to obtain a most suitable exposure value. The movement of object may be shown by adjusting the shutter speed. High shutter speed can make you clearly capture the movement of fast moving object while low shutter speed can allow you to take a picture for fast moving object with a strong sense of movement. (Adjustable in **Tv M** Mode)



## Aperture Adjustment

You can adjust the aperture value. Selecting a large aperture opening will emphasize the point of focus and show a blurry background and foreground. A small aperture opening will keep both the background and main object in clear focus.

(Adjustable in **Av M** Mode)

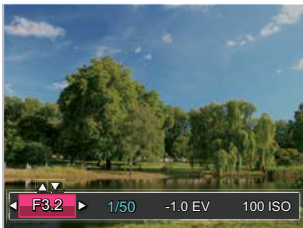

## Using Quick Recording

In shooting mode, press the Fast Video Recording Button  to begin recording video.



Press the Fast Video Recording Button or the Shutter Button to stop and store the video. The camera will return to shooting mode automatically.



## i Button Function Menu

Mode: **P Tv Av M** 



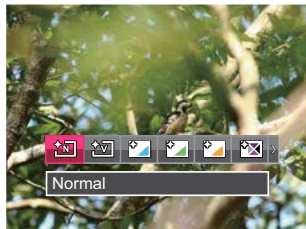

























The Image Color Setting allows you to select different color effects.

1. Press the  button to select the Image Color Setting Menu.
2. Press the left/right arrow button to select the Image Color Setting option.



 () represents optional in the recording mode.

There are 20 Image Color options in photo shooting mode **P Tv Av M** :

Options	Options	Options
 Normal (  )	 Sepia (  )	 Vignetting
 Vivid (  )	 Partial Color-Red (  )	 Salon
 Japan Style	 Partial Color-Blue (  )	 Fish Eye
 Italian Style	 Partial Color-Yellow (  )	 Reflection
 French Style	 Partial Color-Green (  )	 4 Grids - Stylish(2M)
 Punk	 Negative	 Sketch
 Black and White (  )	 Dreamy	



# PLAYBACK

## Overview of the Screen Icons in Playback Mode

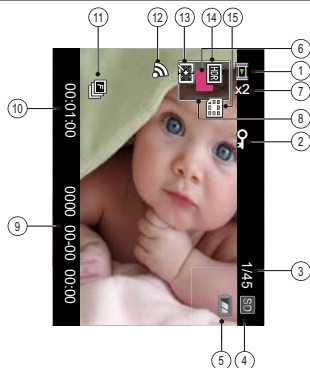
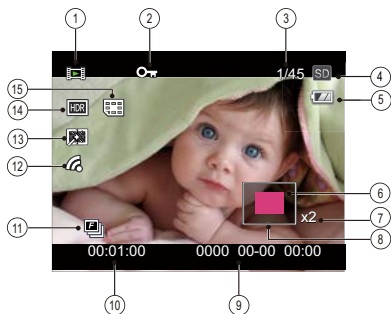

1	Playback mode icon	9	Shooting Date
2	File Protection	10	Film length
3	Memory Space (indicating the current number of photos and total number of photos)	11	Continuous Capture Group Playback
4	Memory Card/Built-in Memory	12	Eye-Fi ON
5	Battery Status	13	Red-Eye Reduction
6	Zoom Magnification Area	14	HDR
7	Image Zoom Ratios	15	Date Folder
8	Image Zone		

## Viewing Photos and Videos

To view photos and videos on LCD screen:

1. After press the **[E]** button, the last photo or video clip taken will be displayed on the LCD screen.
2. Use the left/right arrow button to scroll through the photos or video clips stored in the internal memory or on the memory card.
3. To play a selected video, press the **[OK]** button to enter the Movie Playback Mode.

An operation guide appears on the screen when playing back a video. Press the appropriate buttons to enable the corresponding functions.

Play mode

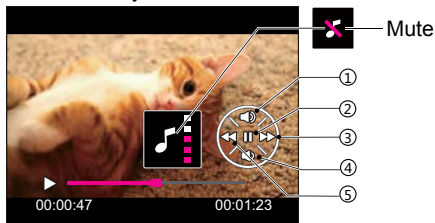

1	Increase Volume
2	Pause
3	Fast Forward
4	Decrease Volume
5	Rewind

Pause mode

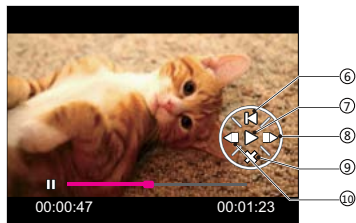

6	Back to the beginning of the video
7	Play
8	Play video forward
9	Cancel playback
10	Play video backward

## Thumbnail View

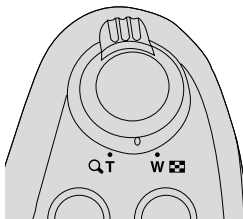

When in Playback Mode, rotate the Zoom Lever counterclockwise to the **W**  position to display thumbnail images of the photos and videos on the screen. (The picture is displayed in horizontal position)

W Zoom Out  T Zoom In



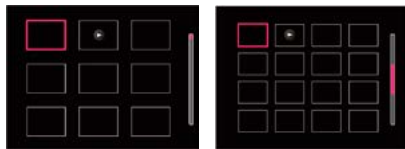

1. Slide the Zoom Lever to switch between 3x3 and 4x4 thumbnails.





2. Press the arrow buttons to select a picture or video clip to view and press the **OK** button to restore it to the original size.  
  
 If the  indicator appears on the LCD, then a movie file is currently being displayed.

## Using Zoom Playback (for still pictures only)

When playing back photos, you can also use the Zoom Lever to zoom in on the photos 2 to 8 times.

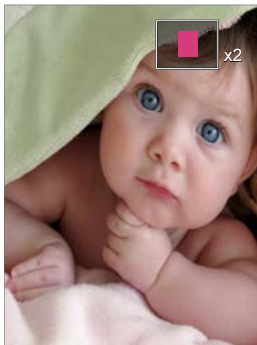
1. Press the  button to switch to Playback Mode.
2. Press the left/right Button to select a picture to be zoomed in.
3. Rotate the Zoom Lever clockwise to  to zoom in.
4. The screen will display the number of times and area of the photo zooming operation.





5. Press the arrow buttons to navigate and select a part of the image to be zoomed in.
6. Press the  button to return the image to its original scale.





Movie images cannot be magnified.

## Photos and Video Deletion

In playback mode, press the down arrow button   to delete your photos and videos.

To delete photos or videos:

1. Press the  button to switch to playback mode.
2. Press the left/right arrow button to select the photos and videos to be deleted.
3. Press the down arrow button   and the deletion screen is displayed.

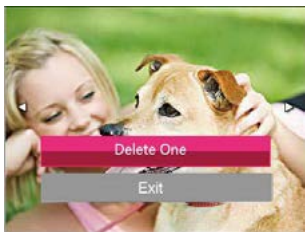

4. Press the up/down arrow button to select [Delete One] or [Exit] and press the  button to confirm.





Erased photos/video clips cannot be recovered.





Please refer to page 79 for instructions on deleting more than one image at a time.

## Slideshow



This setting allows you to view all the stored images as a slideshow.

1. Press the  button to enter the playback screen.
2. Press the  button to enter slide option.
3. Press the left/right Button to select slideshow playing or [Cancel] to return to the playback screen.





-  : interval 1sec, slowly fade out
-  : interval 1sec, disappear from the center
-  : interval 1sec, dissolve

4. Press the  button to confirm the setting.

-  The continuous capture group playback may be displayed by slideshow.
-  Pictures rotate automatically during a slide show.
-  Slide playing function supports movie playing.

## Continuous Capture Group Playback

Cont. Shot-High Speed (VGA) and Cont. Shot-Fast (4M) images can be played back.



1. Press the  button to enter the playback screen.
2. Press the left/right arrow button to select Cont. Group.
3. Press the  to start playback.



# USING THE MENUS

## Photo Shooting Menu

Mode: **AUTO P Tv Av M**   **SCN**

1. In Photo Shooting Mode, press the  button to enter the Photo Shooting Menu.
2. Press the up/down arrow button to select the Photo Shooting Menu to be set.
3. Press the left/right arrow button to select an option and press the  button to confirm.



Refer to the following pages for more details about each setting.

### Expo Metering (Exposure Metering)

Use this setting to select the "target" size of the camera's field of view to be metered.



There are 3 options:

-  **AiAE (Artificial Intelligence AE):** Automatically selects the central and peripheral metering, to calculate the reasonable value of exposure.
-  **Spot metering** targets a small area in the center of the camera's field of view.
-  **Center metering** targets a slightly larger area in the center of the camera's field of view.



## Image Size

The size setting refers to the image resolution in pixels. A higher image resolution allows you to print that image in larger sizes without degrading the image quality.

**16M** (16M): High quality printing

**14M** (14M): Full size printing

**12M** (12M): 16:9 display

**10M** (10M): Poster printing

**5M** (5M) : A3 printing

**3M** (3M) : A4 printing

**2M** (2M) : 4"x 6" printing

**VGA** (VGA): E-Mail



The bigger the number of recorded pixels is, the better the image quality becomes. As the number of recorded pixels lessen, you will be able to record more images on a memory card.



## OIS

This mode can help reduce photo blur caused by unintentional hand shake, or low light.

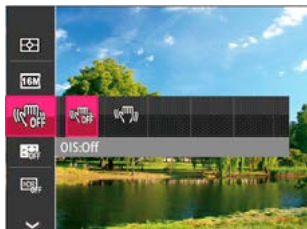

Use this image stabilization mode in dark environments.



Shooting in a windy or unstable environment (such as a moving vehicle) may cause blurred images.

## Cont. AF

Enable the continuous AF to be able to continuously focus automatically when taking pictures.



There are 2 options:

 : Off

 : On

## HDR

Photos with extreme contrast of bright and dark areas will still maintain distinguishable detail and depth. (Use of tripod is recommended)



There are 2 options:

 : Off

 : On





In the scenario with high light contrast (too dark or too light), this function can be used to shoot satisfactory photos.

## Beauty

Set the effect of the beauty mode.



Beautifier Mode has 3 effects:

-  Effect 1: Skin Soften
-  Effect 2: Skin Soften + Eye Brightening
-  Effect 3: Skin Soften + Eye Brightening + Eye Enlargement

## Scene

Select the scene mode under the SCN mode.

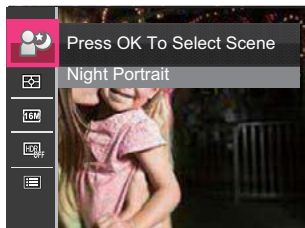



- Shooting menu in the shooting mode  
(○: Optional ×: Not optional)





Options	Shooting Modes						
	AUTO	P	Tv	Av	M		
	○	○	○	○	○	○	○
<b>16M</b>	○	○	○	○	○	○	○
	×	○	○	○	○	○	×
	×	○	○	○	○	○	×
<b>HDR</b> OFF	×	○	○	○	○	×	×
	×	×	×	×	×	○	×

## Photo Shooting Setting Menu

Mode: **AUTO P Tv Av M** +   **SCN**

1. Press the  button in Photo Shooting Mode and press the up/down button to select  .



2. Press the  button to enter the menu.
3. Press up/down arrow button to select  , and press the  button or right arrow button to enter the menu.
4. Press the up/down arrow button to select an item to be set and press the  button or right arrow button to enter the menu.
5. Press the up/down arrow buttons to select an option and press the  button to confirm.

### Quality

The Quality Setting can be used to adjust the image compression ratio.

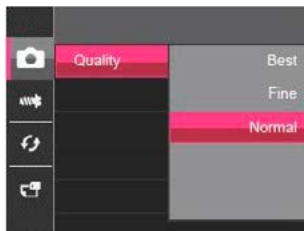

There are 3 options for picture quality:

- Best  
(16M Average File Size: 3.2MB)
- Fine  
(16M Average File Size: 2.5MB)
- Normal  
(16M Average File Size: 2.1MB)

## AF-Assist Beam

In a darker environment, AF Assist Beam can be turned on for better focus.

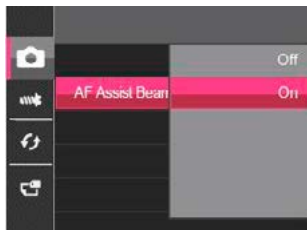

## Date Imprint

Include a Date/Time stamp on the photo image.

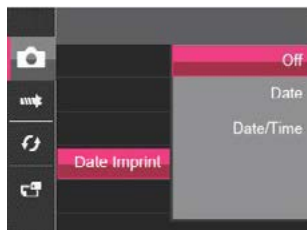

## Digital Zoom

Turn on or off the digital zoom.



- Off
- Date
- Date/Time

## Quick Review

This option allows quick review of the photos immediately after they are taken. Each photo is displayed on the LCD screen based on the selected time.



There are 4 options:

- Off
- 1 sec
- 2 sec
- 3 sec

## Custom Settings

Custom Settings stores the current mode and its parameters. The stored mode and parameters are directly invoked in Custom Settings mode.

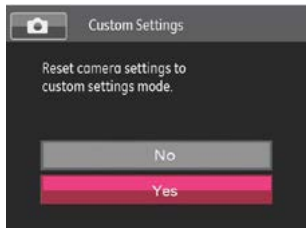



There are 2 options:

- No
- Yes

## Movie Menu

Mode: 

1. Turn the mode dial, select the  mode and press the  button to enter the Movie Menu.

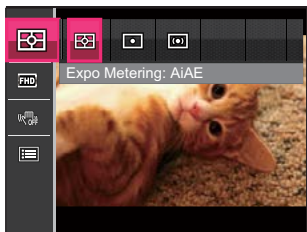



2. Press the up/down arrow button to select the Movie Menu to be set.
3. Press the left/right arrow button to select an option and press the  button to confirm.

## Expo Metering (Exposure Metering)

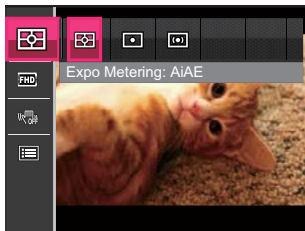
Use this setting to select the "target" size of the camera's field of view to be metered.



There are 3 options:





-  AiAE (Artificial Intelligence AE): Automatically selects the central and peripheral metering, to calculate the reasonable value of exposure.
-  Spot metering targets a small area in the center of the camera's field of view.
-  Center metering targets a slightly larger area in the center of the camera's field of view.

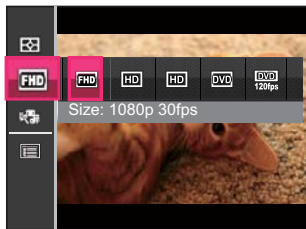

## Video Quality

Set the image resolution used during video recording.







Settings	Image Pixel	Frame Rate	Recording time (2GB) About
	1920x1080	30fps	11min. 46sec.
	1280x720	60fps	12min. 39sec.
	1280x720	30fps	23min. 39sec.
	640x480	30fps	53min. 51sec.
	640x480	120fps	20min. 40sec.

\* The frame rate (fps) indicates the number of frames per second.

\* You can continue recording until the recorded time reaches 25 minutes per a recording. (excluding )

 When recording in higher pixel resolutions for extended periods of time, this can cause the camera to generate heat. This is not a camera malfunction.

 When the video format is set as , shooting time is maximum 30 seconds, playback time is 2 minutes.

 Sound recording is disabled when  is chosen.

 Use an SD memory card with Class 4 or higher for the video recording.

## OIS

This mode can help reduce photo blur caused by unintentional hand shake, or low light.

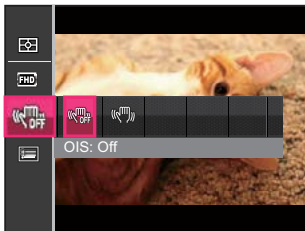





 Use this image stabilization mode in dark environments.





 Shooting in a windy or unstable environment (such as a moving vehicle) may cause blurred images.

## Movie Setting Menu

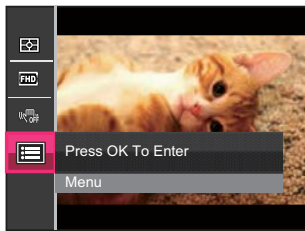
Mode: 

1. Turn the Mode Dial and select  to enter the video recording screen.
2. Press the  button, press the up/down arrow button to select , and press the  button to enter the menu.



3. Press up/down arrow button to select , and press the  button or right arrow button to enter the menu.
4. Select an item to be set and press the  button or the right arrow button to enter the menu.
5. Press the up/down arrow buttons to select an option and press the  button to confirm.

## Digital Zoom

Turn on or off the digital zoom.

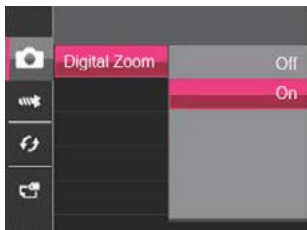

There are 2 options:

- Off
- On

## Custom Settings

Custom Settings stores the current mode and its parameters. The stored mode and parameters are directly invoked in Custom Settings mode.

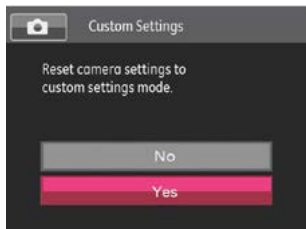





There are 2 options:

- No
- Yes

## Playback Menu

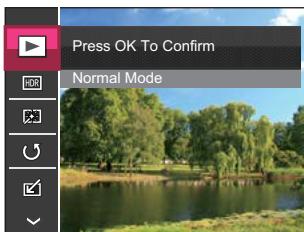

Mode: 

1. Press the  button to display the playback screen and press the  button to enter the menu.
2. Press the up/down arrow button to select the menu to be set and press the  button to enter.
3. Press the left/right arrow buttons to select an option and press the  button to confirm.





Refer to the following pages for more details about each setting.

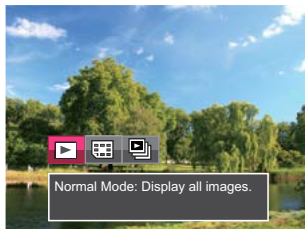

## Playback

1. Press the  button, select the  settings, and press the  button to display the settings screen.
2. Press the left/right button to select from the following 3 functions:





-  Normal Mode: Display all images.
-  Date Mode: Arranged by date.
-  Cont. Photo Mode: Arranged by Cont. Photo Group.

3. Press the **OK** button to confirm the setting.



-  The Date Folder is displayed in date order based on photo shooting date/time.
-  If there is no any continuous capture image file in the memory, continuous capture playback mode cannot be enabled.

## HDR

With the HDR function, pictures that are overexposed may be corrected to optimize the highlights and lowlights captured to more accurately represent the actual scene.

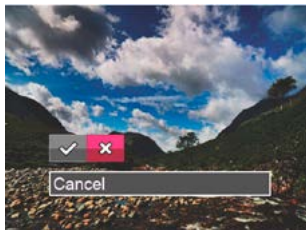

1. In Playback Mode, press the left /right arrow button to select the photo to be edited.
2. Press the  button, select the  settings, and press the **OK** button to display the settings screen.
3. Press the left/right button to select whether HDR is used.



 : HDR     : Cancel

4. After using the HDR function, the image will be saved as a new file and the original file is still stored in the memory.

## Touch-up

1. In Playback Mode, press the left /right arrow button to select the photo to be edited.
2. Press the  button, select the  settings, and press the  button to display the settings screen.
3. Press the left/right button to select Touch-up options or [Cancel] to return to the playback screen.



 : Red-Eye Reduction

 : Skin Soften

 : Eye Brightening

 : Eye Enlargement



 : Cancel

4. Press the  button to confirm the setting.

 The Touch-up mentioned here is the individual beautification for three effects, beauty mode allows you to select from single, two, or all three effects combined.

## Rotate

You can use this setting to change the orientation of the picture.

1. In Playback Mode, press the left /right arrow button to select the photo to be edited.
2. Press the  button, select the  settings, and press the  button to display the settings screen.
3. Press the left/right button to select the rotation direction or [Cancel] to return to the playback screen.

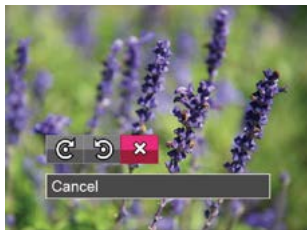



 : Turn Right

 : Turn Left

 : Cancel



4. Press the  button to confirm the setting.

 Videos cannot be rotated.

 The rotated picture file will replace the original photo.

## Resize

This setting allows you to resize a picture to a particular resolution and saves it as a new picture.

1. In Playback Mode, press the left /right arrow button to select the photo to be edited.
2. Press the  button, select the  settings and press the  button to display the settings screen.
3. Press the left/right arrow button to select [1024] or [640] or select [Cancel] to return to the playback screen.

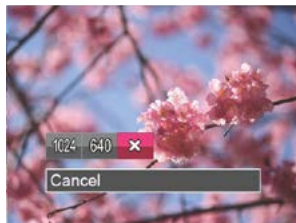

**1024** : Resize to 1024x768

**640** : Resize to 640x480

**x** : Cancel

4. Press the  button to confirm the setting.



## i Button Playback Function





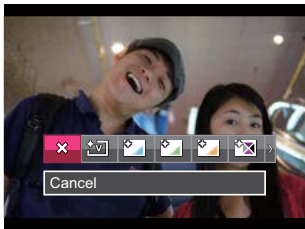







This setting allows you to change the picture color effect. The file is saved as a new photo and stored in the memory together with the original photo.

1. In Playback Mode, press the left /right arrow button to select the photo to be edited.
2. Press the  button to select the Image Color Setting Menu.
3. Press the left/right button to select the corresponding menu or [Cancel] to return to the playback screen.







4. Press the  button to confirm the setting.

There are 19 options:



-  Cancel
-  Vivid
-  Japan Style (8M)
-  Italian Style (8M)
-  French Style (8M)
-  Punk (4M)
-  Black and White
-  Sepia
-  Partial Color-Red
-  Partial Color-Blue
-  Partial Color-Yellow
-  Partial Color-Green
-  Negative (8M)
-  Dreamy
-  Vignetting
-  Salon
-  Fish Eye
-  Reflection
-  4 Grids - Stylish (2M)

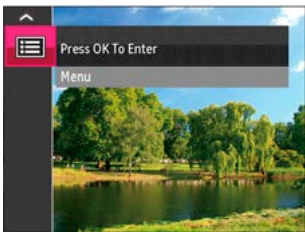

## Playback Setting Menu

Mode: 

1. Press the  button to show the playback screen, press the  button, and press the up/down button to select .
2. Press the  button to enter the menu.



3. Press up/down arrow button to select , and press the  button or right arrow button to enter the menu.

4. Press the up/down arrow button to select an item to be set and press the  button or right arrow button to enter the menu.
5. Press the up/down arrow buttons to select an option and press the  button to confirm.

Refer to the following pages for more details about each setting.

## Protect

To prevent any pictures or videos from being accidentally erased, use this setting to lock one or all of the files.

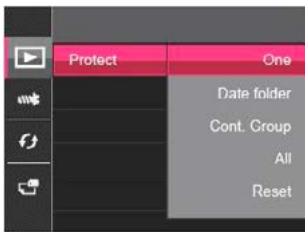

To lock or unlock the photo and video files:

1. Press the up/down arrow button to select [Protect] and press the **OK** button or right arrow button to enter the submenu.
2. Press the up/down arrow button to select the submenu and press the **OK** button or right arrow button to show the settings screen.

There are 5 sub menus available:

- One  
Lock the selected photo or video if it is unprotected; unlock the selected photo or video if it is protected.
  - Date Folder  
Protect all photos in the Date Folder.
  - Cont. Group  
Protect all photos in the Cont. Group.
  - All  
Lock all photos or videos.
  - Reset  
Cancel all locked photos or videos.
3. Press the up/down arrow buttons to select an option and press the **OK** button to confirm.

## Delete

You can delete one or all photo/video files.

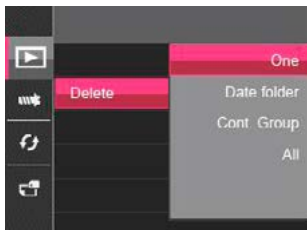

To delete photo or video files:

1. Press the up/down arrow button to select [Delete] and press the **(OK)** button or right arrow button to enter the submenu.
2. Press the up/down arrow button to select the submenu and press the **(OK)** button or right arrow button to show the settings screen.

There are 4 sub menus available:

- One  
Delete one photo or video.
- Date Folder  
Delete all photos in the Date Folder.
- Cont. Group  
Delete all photos in the Cont. Group.
- All  
Delete all photos or videos.

3. Press the up/down arrow buttons to select an option and press the **(OK)** button to confirm.



The “” indicator means a file is protected. File protection must be removed first before a file can be deleted.



When one photo in the Cont. Group and Date Folders is protected, it will be kept but any other photos will be deleted.

## Trim

The Trim Setting allows you to crop photos and save them as new pictures.

1. Press the up/down arrow button to select [Trim] and press the **OK** button or right arrow button to enter the menu.
2. Select [Yes] to confirm trim. Select a part to be trimmed using the Zoom Lever and arrow buttons to trim a photo.









3. Press the **OK** button and the [Save Change?] prompt appears. Select **[✓]** to change and save the picture. Select **[✗]** to cancel changes and return to the trim prompt screen.



The image cannot be clipped/trimmed again once it has been clipped to 640X480.

## Setup Menu

Mode: **AUTO P Tv Av M** +   **SCN**  

1. Press the  button in any mode and press the up/down button to select .
2. Press the  button to enter the menu.
3. Press up/down arrow button to select , and press the  button or right arrow button to enter the menu.
4. Press the up/down arrow button to select an item to be set and press the  button or right arrow button to enter the menu.
5. Press the arrow buttons to select an option and press the  button to confirm.

Refer to the following pages for more details about each setting.

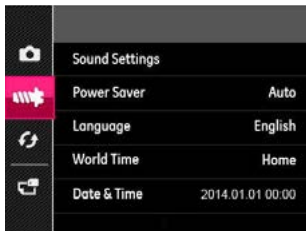

## Sound Settings

The Keypress tone and the shutter sound has been set.

To change this setting:

1. Select [Sound Settings] in the basic settings menu. Press the **(OK)** button or right arrow button to enter the menu.
2. Press the left/right arrow button to select an option.

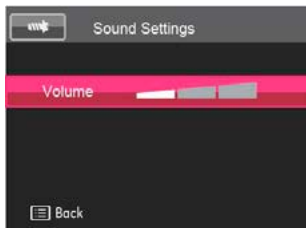

3. Press the **(OK)** button to confirm.

## Power Saver

This setting allows you to save power and get the maximum possible running time for your camera's battery. Follow the steps below to turn the LCD screen and camera off automatically after a consecutive period of inactivity.

1. Select [Power Saver] in the basic settings menu. Press the **(OK)** button or right arrow button to enter the menu.
2. Press the up/down arrow button to select an option.



3. Press the **(OK)** button to confirm.



Power Saver	LCD power off time	Turn off time
Auto	3 min	5 min
Normal	1 min	3 min
Best	30 s	1 min

## Language

Refer to the “Resetting your language” section on page 25.

## World Time

The World Time setting is a useful function for your overseas trips. This feature enables you to display the local time on the LCD screen while you are abroad.

1. Select [World Time] in the basic settings menu. The World Time screen appears.
2. Press the up/down to select the departure place (  ) and destination (  ) fields.



3. Press the left/right arrow button to select a city located in the same time zone as that of the field. Press the  button to confirm settings.

## Date/Time

Refer to the “Resetting Date/Time” section on page 26.

## LCD Brightness

Use this setting to adjust the brightness of your LCD screen.

1. Select [LCD Brightness] in the basic settings menu. Press the  button or right arrow button to enter the menu.
2. Press the up/down arrow button to adjust the brightness.

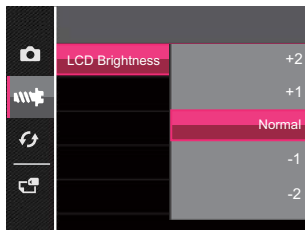







- + : Brighter
  - - : Darker
3. Press the  button to confirm.



### Format Memory

Please note: formatting enables you to delete all contents in the memory card and built-in memory, including protected photos and movie files.

To use this setting:







1. Press the  button, press the up/down arrow button to select  and press the  button to enter the menu.
2. Press up/down arrow button to select  and press the  button or right arrow button to enter the menu.
3. Press the up/down arrow button to select [Format] and press the  button or right arrow button to enter the menu.
4. Press the up/down arrow buttons to select [Yes] or [No] and press the  button to confirm.
5. If you select [Yes] the camera formats its memory.



-  If there is no memory card in the camera, the built-in memory will be formatted; if there is a memory card, it will be formatted only.

## Copy to Card

Use this setting to copy the files stored in the internal memory to a memory card.



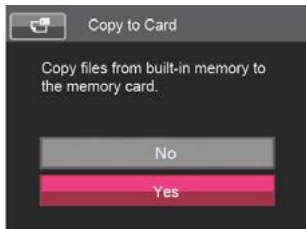



1. Press the  button, press the up/down arrow button to select  and press the  button to enter the menu.
2. Press up/down arrow button to select  and press the  button or right arrow button to enter the menu.
3. Press the up/down arrow button to select [Copy to Card] and press the  button or right arrow button to enter the menu.
4. Press the up/down arrow buttons to select [Yes] or [No] and press the  button to confirm.



If there is no card available in the camera, this function will not be displayed.

## File Numbering





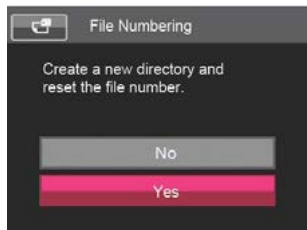

After you take a picture or video clip, the camera will save it with a sequential number. You can use this setting to reset the file numbering to 0001.

1. Press the  button, press the up/down arrow button to select  and press the  button to enter the menu.
2. Press up/down arrow button to select  and press the  button or right arrow button to enter the menu.
3. Press the up/down arrow button to select [File Numbering] and press the  button or right arrow button to enter the menu.
4. Press the up/down arrow buttons to select [Yes] or [No] and press the  button to confirm.



## Reset





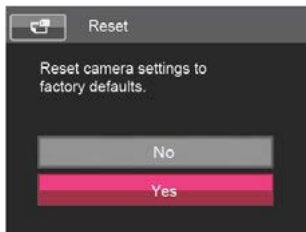

Use this setting to restore the camera to its original default settings.

1. Press the  button, press the up/down arrow button to select  and press the  button to enter the menu.
2. Press up/down arrow button to select  and press the  button or right arrow button to enter the menu.
3. Press the up/down arrow button to select [Reset] and press the  button or right arrow button to enter the menu.
4. Press the up/down arrow buttons to select [Yes] or [No] and press the  button to confirm.



## FW Version

Use this setting to display the current camera firmware version.

1. Press the  button, press the up/down arrow button to select  and press the  button to enter the menu.
2. Press up/down arrow button to select  and press the  button or right arrow button to enter the menu.
3. Press the up/down arrow button to select [FW Version] and press the  button or right arrow button to display the current version.

# CONNECTIONS

## Connecting to a Computer

You can use the USB cable to connect the camera and copy (transmit) images to a computer.

### Transferring images to your computer

#### Viewing Images on Computer

Display transferred images on a standard image viewer etc. that an OS has. For details about viewing images, see the help menu on the viewer.

Support OS==>Windows: Windows Vista® / Windows® 7 / Windows® 8 / Windows® 8.1

Machintosh: Mac OS X 10.6.8, OS X 10.7 / 10.8

Follow the steps below to connect the camera to a computer.



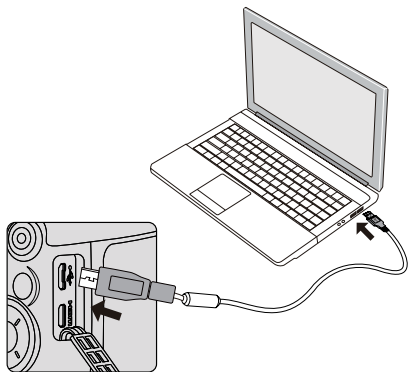



1. Make sure the computer is turned on.
2. Connect one end of the supplied USB cable to the USB/AV port on your camera.
3. Connect the other end of the USB cable to an available USB port on your computer.
4. The computer will automatically detect the camera as a removable drive. Double-click the My Computer icon on the desktop to locate the removable drive and to copy folders and files in the drive to a directory on your PC as you would copy any typical folder or file.
5. After the transmission is complete, disconnect the USB cable according to the instructions specifying how to safely remove USB devices.



## Video System

You can use an AV cable (which should be purchased separately) to connect the camera and the television for realizing the video output. Turn the camera and television off, and then connect one end of the AV cable to AV port of the camera; connect the other end to AV-OUT port of the television, and turn the camera and television on. Adjust the format of the video output system according to your requirements before connecting the camera. The steps are as follows:

\* When connecting camera to TV, nothing is displayed on the LCD screen.

1. Press the  button, press the up/down arrow button to select  and press the  button to enter the menu.
2. Press up/down arrow button to select  and press the  button or right arrow button to enter the menu.
3. Press the up/down arrow button to select [TV-System] and press the  button or right arrow button to enter the menu.
4. Press the up/down arrow buttons to select [NTSC] or [PAL] and press the  button to confirm.









 The video output system would change accordingly based upon the changes of the selected language.

NTSC: English, Japanese, Korean

PAL: German, Spanish, Italian, Chinese (Simplified), Chinese (Traditional), French, Russian, Vietnamese, Greek, Hungarian, Portuguese, Swedish, Danish, Finnish, Indonesian, Norwegian, Dutch, Turkish, Polish, Croatian, Czech, Arabic, Hindi, Thai

## Set Eye-Fi Card Connection Mode

This camera supports the wireless connection for Eye-Fi memory card. Enable Eye-Fi connection by following below steps.

1. Press the  button, press the up/down arrow button to select  and press the  button to enter the menu.
2. Press up/down arrow button to select  and press the  button or right arrow button to enter the menu.
3. Press the up/down arrow button to select [Eye-Fi] and press the  button or right arrow button to enter the menu.
4. Press the up/down arrow buttons to select [On] or [Off] and press the  button to confirm.

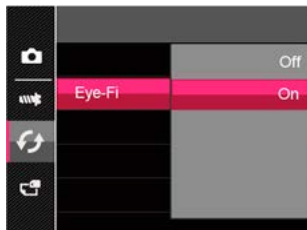

 If the Eye-Fi card is not inserted in the camera, this feature is not displayed.

## Supported HDMI Connections

HDMI (High Definition Multimedia Interface), is a fully digital audio/video transmission interface, through which uncompressed audio and video signals are transmitted.

Direct transmission of digital video signals to your TV reduces conversion loss and improves image quality.

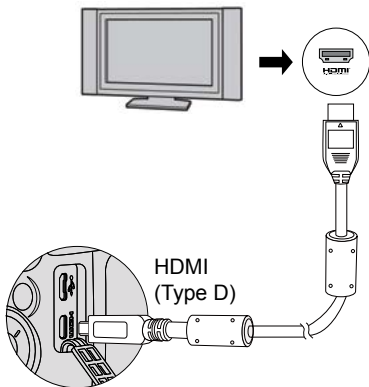

### Connecting to an HDMI-Ready TV

1. Use a cable with high resolution output terminal (which should be purchased separately) to connect the camera to the television which meets HDMI standard.
2. The camera will be automatically detected by the TV.
3. After connecting via HDMI, the camera enters Playback Mode.

\* When connecting camera to TV, nothing is displayed on the LCD screen.



Make sure the camera and the TV are both turned on before connecting.



Refer to your TV instruction manual for information on what resolution sizes it will support. The resolution and output formats that are not supported will be grayed out on the camera's LCD screen.

# APPENDICES

## Main Specifications

Type	Fully automatic compact digital still camera with built-in zoom lens
Number of effective pixels	Approx. 16 megapixels
Image sensor	1/2.3 inch CMOS
Number of recorded pixels	Still 16M(4608x3456), 14M(3:2)(4608x3072), 12M(16:9)(4608x2592), 10M(3648x2736), 5M(2592x1944), 3M(2048x1536), 2M(16:9)(1920x1080), VGA(640x480) * Fixed at VGA(640x480) in Cont. Shot-High Speed mode. * Fixed at 4M in Cont.Shot-Fast mode.
	Movie 1920(1920x1080.30fps), 1280(1280x720.60/30fps), 640(640x480.30fps), High Speed Movie(640x480.120fps) * No sound will be recorded in High Speed Movie.
Sensitivity	Auto, Manual (ISO100-3200)
File format	Still JPEG (Exif 2.3), DCF1.0
	Movie MOV/H.264, 30 fps/60fps/120fps, PCM system, stereo sound
Quality level	Still Best, Fine, Normal
Storage media	Built-in memory (approx. 15.4 MB), SD Memory Card, SDHC Memory Card, Eye-Fi card compatible



## Approximate Image Storage Capacity and Recording Time Still

	Built-in Memory			2 GB SD Memory Card		
	Best	Fine	Normal	Best	Fine	Normal
16M(4608x3456)	2 pictures	4 pictures	5 pictures	410 pictures	623 pictures	754 pictures
14M(4608x3072)	3 pictures	4 pictures	6 pictures	458 pictures	694 pictures	838 pictures
12M(4608x2592)	3 pictures	5 pictures	7 pictures	538 pictures	810 pictures	975 pictures
10M(3648x2736)	4 pictures	7 pictures	8 pictures	635 pictures	951 pictures	1140 pictures
5M(2592x1944)	8 pictures	13 pictures	15 pictures	1170 pictures	1692 pictures	1988 pictures
3M(2048x1536)	13 pictures	19 pictures	22 pictures	1726 pictures	2412 pictures	2780 pictures
2M(1920x1080)	19 pictures	26 pictures	30 pictures	2362 pictures	3176 pictures	3589 pictures
VGA(0.3M)(640x480)	48 pictures	54 pictures	57 pictures	6010 pictures	6653 pictures	6899 pictures

- The image storage capacity is for reference only. The actual image storage capacity may vary depending on the SD Memory Card and the subject.

## Movie

	Built-in Memory	2 GB SD Memory Card
1920x1080.30fps	-	11min. 46sec.
1280x720.60fps	-	12min. 39sec.
1280x720.30fps	5sec.	23min. 39sec.
640x480.30fps	19sec.	53min. 51sec.
640x480.120fps	4sec.	20min. 40sec.

- The above figures are based on our standard shooting conditions and may vary depending on the subject, shooting conditions and type of the SD Memory Card used.
- You can continue recording until the recorded time reaches 25 minutes (only 640x480.120fps is 30 seconds) per a recording.

White balance	AWB, Daylight, Cloudy, Fluorescent, Fluorescent CWF, Incandescent, Manual WB, Color Temp. (1900K~10000K)
Lens	Focal Length      4.3 - 223.6 mm (approx. 24mm - 1248mm in 35 mm format equivalent)
	Maximum Aperture F2.8(W) - F5.6(T)
	Lens Construction 15 elements in 13 groups (6 aspherical elements)
	Zoom Type            Electrically driven
Optical zoom	52x
Digital zoom	Max. approx. 4× (combines with 52× optical zoom to give zoom magnification equivalent to 208×)
Motion blur reduction	Still                    Sensor-Shift Type (also in Handheld Night mode)
	Movie                  Electronic movie shake reduction
Display	3.0-inch LCD, approx. 460,000 dots
View finder	Electronic view finder with approx. 200,000 dots
Playback modes	Single-frame, 9/16 thumbnails, Slideshow, Date Mode, Cont. Photo Mode, Zoom (2x - 8x), Movie

Focus mode	Single-AF, Multi-AF (24 points), Object Tracking, Continuous AF, Macro	
Focus	Type	TTL contrast detection system by sensor
	Focus range (From lens face)	Standard: 0.6m - ∞ (Wide-angle) 3.0m - ∞ (Telephoto) Macro : 0.01m - ∞ (Wide-angle only) 0.3m - ∞ (At the intermediate position of the zoom range)
	Focus Lock	By half-pressing the shutter release button
Exposure control	AE Metering	AiAE, Spot metering, Center metering, Face AE
	EV Compensation	±3 EV (can be set in 1/3 EV steps)
Face detection	Detection of up to 12 people's faces, Smile, Blink	
Pet detection	Up to 10 dogs/cats	
Shooting mode	Auto Mode, Program AE, Shutter priority, Aperture priority, Manual Mode, Face Beautifier, Handheld Night, Scene Mode [Pet Mode, Sunset, Fireworks, Multi Exposure, Sport, Night Portrait, Landscape, Portrait, Snow, Children, Party], Movie Mode, Custom Settings, HDR	

Digital filter	Cancel, Vivid, Japan Style (8M), Italian Style (8M), French Style (8M), Punk (4M), Black and White, Sepia, Partial Color-Red, Partial Color-Blue, Partial Color-Yellow, Partial Color-Green, Negative (8M), Dreamy, Vignetting, Salon, Fish Eye, Reflection, 4 Grids - Stylish (2M), HDR, Red-Eye Reduction/ Skin Soften/Eye Brightening/Eye Enlargement/Cancel, Rotate (Turn Right/Turn Left/Cancel), Resize (1024/640/Cancel), Trim, Normal (in shooting mode only), Sketch (in shooting mode only)
Movie	Continuous Recording Time      Approx. 1 second - 25 minutes (however, 30 seconds at 640x480.120fps)
Shutter speed	1/2000 sec. - 4 sec., max. 30 sec. (Manual Mode)
Built-in flash	Modes      Force Off, Flash Auto, Force Flash, Slow Sync., Slow Sync. + Red-Eye, Red-Eye Reduction
	Flash Range      Wide-angle: approx. 0.5m - 7.5m (approx. 1.64ft. - 25ft.) (Sensitivity: ISO 800) Telephoto: approx. 1.2m - 3.7m (approx. 3.9ft. - 12ft.) (Sensitivity: ISO 800)
Drive mode	Single, Continuous Shot, Cont. Shot-High Speed (VGA), Cont. Shot-Fast (4M), Time-Lapse (30sec/ 1min/5min/10min), Self-timer (2 sec/10 sec/Smile)
Self-timer	Electronic control type, 2 sec, 10 sec, Smile
Time function	World Time      48 cities (24 time zones)

Power source	Rechargeable lithium-ion battery LB-060	
Battery life	Image Storage Capacity Approx. 240 pictures	* According to the results of in-house testing.
	Playback Time Approx. 200 min.	* According to the results of in-house testing.
	Movie Recording Time Approx. 95 min.	* According to the results of in-house testing.
Interfaces	USB 2.0 /USB/AV port / HDMI port (Type D)	
Video output format	NTSC/PAL	
Dimensions	Approx. 119 (W) × 89 (H) × 97.5 (D) mm (excluding operating or protruding parts)	
Weight	Approx. 539g (excluding battery and SD Memory Card) Approx. 567g (including battery and SD Memory Card)	
Accessories	Rechargeable lithium-ion battery, Power adapter, USB cable, Strap, Lens cap, Operating Manual (CD-ROM), Quick start guide	

## Prompts and Warning Messages

Message	Description	Action
Warning! Battery exhausted.	The camera battery is used up. It is a warning indicating that the camera is going to shut down.	Charge the battery.
Lens obstruction, Re-start Camera.	The lens is jammed or some foreign object is preventing the lens from functioning properly.	Turn off the camera and restart it to reset the lens.
Suggest using tripod.	The message will appear when shooting in low light/illuminated scenes.	Use of a tripod or other support is suggested.
Built-in memory error!	An error occurs in the internal memory.	Format the internal memory.
Connection Failed!	Failure to connect to your PC/Television (Video).	Remove USB cable and retry connection.
Write Protect !	The memory card is locked.	Unlock the write-protect switch of the memory card.

<b>Message</b>	<b>Description</b>	<b>Action</b>
Card Full !	Indicates that the SD memory card is full.	Insert a new SD memory card or delete unwanted images.
Memory Full !	Indicates that the internal memory is full.	Insert a new SD memory card or delete unwanted images.
Card Error !	The SD memory card can't be identified after being formatted.	Insert a new SD memory card or format the card with this camera.
Card is not formatted.	The inserted SD memory card is unformatted or has been formatted on a computer or other device and is not compatible with this camera.	The message will disappear after 2 seconds. Format the SD memory card with this camera.
Slow access	When an SD memory card lower than Class 4 is used to record an HD movie, the writing speed will be slower and recording will not continue.	Use an SD memory card with Class 4 or higher.

<b>Message</b>	<b>Description</b>	<b>Action</b>
No Red-Eye Detected!	Red eyes have not been detected in the image.	The message will disappear after 2 seconds.
This image cannot be edited.	The file cannot be edited or the edited file cannot be edited again.	The message will disappear after 2 seconds.
Exceeded maximum folder number.	Prompt message when the archives or file folders in the memory card have reached the maximum (9999 for archives, 999 for file folder).	Copy the images to your PC and format the SD memory card with this camera.
Too many pictures for quick processing.	During the playback by date, the images are too many to play.	This may be solved by deleting unnecessary images.
Unable to recognize files.	The format of the file to be viewed is not supported or the file is corrupted so it cannot be properly read.	You may be able to play it back on another brand of camera or on your computer.



<b>Message</b>	<b>Description</b>	<b>Action</b>
No Picture!	When you press the play button, no image files exist in the camera or memory card.	The message disappears 2 seconds later to return to the photo shooting screen.
No continuous group file.	When you play back the images in continuous photo mode, there is no continuous group file.	The message disappears after 2 seconds and the camera returns to the normal playback mode.
Protected! Undeletable!	The file is protected. The message appears when you delete it.	Unprotect the file before deleting.

## Troubleshooting

<b>Problem</b>	<b>Possible Causes</b>	<b>Solution</b>
Camera does not turn on	<ul style="list-style-type: none"><li>■ The battery has been depleted.</li><li>■ The battery is not inserted correctly.</li></ul>	<ul style="list-style-type: none"><li>■ Recharge the battery.</li><li>■ Correctly reinstall the battery.</li></ul>
Camera turns off suddenly during operation	<ul style="list-style-type: none"><li>■ The battery has been depleted.</li></ul>	<ul style="list-style-type: none"><li>■ Recharge the battery.</li></ul>
The picture is blurred	<ul style="list-style-type: none"><li>■ Camera shakes while taking a picture.</li></ul>	<ul style="list-style-type: none"><li>■ Turn on the OIS feature.</li><li>■ Please use tripod for high magnification (above 15X) optical zoom.</li></ul>
Images and video files cannot be saved	<ul style="list-style-type: none"><li>■ The SD memory card is full.</li><li>■ The SD memory card is locked.</li></ul>	<ul style="list-style-type: none"><li>■ Use another SD memory card or delete unnecessary files.</li><li>■ Unlock the SD memory card.</li></ul>
Saving data to memory card is slow	<ul style="list-style-type: none"><li>■ Using an SD memory card below Class 4 may result in slower recording times.</li></ul>	<ul style="list-style-type: none"><li>■ Use an SD memory card with Class 4 or higher to improve performance.</li></ul>

<b>Problem</b>	<b>Possible Causes</b>	<b>Solution</b>
Cannot write to the memory card	<ul style="list-style-type: none"><li>■ The SD memory card has been locked.</li></ul>	<ul style="list-style-type: none"><li>■ Release the write lock of the SD memory card or replace with another card.</li></ul>
Too many images to process	<ul style="list-style-type: none"><li>■ The number of pictures or folders in the memory card exceeds the specifications, so the playback of data folder can not be displayed.</li></ul>	<ul style="list-style-type: none"><li>■ Delete unwanted files.</li></ul>

## Warranty Policy

All our cameras purchased through authorized bona fide photographic distribution channels are guaranteed against defects of material or workmanship for a period of twelve months from the date of your purchase. Service will be rendered, and defective parts will be replaced without cost to you within that period, provided the camera does not show evidence of impact, sand or liquid damage, mishandling, tampering, battery or chemical corrosion, operation contrary to operating instructions, or modification by an unauthorized repair shop. The manufacturer or its authorized representatives shall not be liable for any repair or alterations except those made with its written consent and shall not be liable for damages from delay or loss of use or from other indirect or consequential damages of any kind, whether caused by defective material or workmanship or otherwise; and it is expressly agreed that the liability of the manufacturer or its representatives under all guarantees or warranties, whether expressed or implied, is strictly limited to the replacement of parts as hereinbefore provided. No refunds will be made on repairs by non-authorized service facilities.

### Procedure During 12-month Warranty Period

Any camera which proves defective during the 12-month warranty period should be returned to the dealer from whom you purchased the camera or to the manufacturer. If there are no representatives of the manufacturer in your country, send the camera to the manufacturer, with postage prepaid. In this case, it will take a considerable length of time before the camera can be returned to you owing to the complicated customs procedures required. If the camera is covered by warranty, repairs will be made and parts replaced free of charge, and the camera will be returned to you upon completion of servicing. If the camera is not covered by warranty, regular charges of the manufacturer or of its representatives will apply. Shipping charges are to be borne by the owner. If your camera was purchased outside of the country where you wish to have it serviced during the warranty period, regular handling and servicing fees may be charged by the manufacturer's representatives in that country. Notwithstanding this, your camera returned to the manufacturer will be serviced free of charge according to this procedure and warranty policy. In any case, however, shipping charges and customs clearance fees to be borne by the sender. To prove the date of your purchase when required, please keep the receipt or bills covering the purchase of your camera for at least a year. Before sending your camera for servicing, please make sure that you are sending it to the manufacturer's authorized representatives or their approved repair shops, unless you are sending it directly to the manufacturer. Always obtain a quotation for the service charge, and only after you accept the quoted service charge, instruct the service station to proceed with the servicing.

- **This warranty policy does not affect the customer's statutory rights.**
- **The local warranty policies available from our distributors in some countries can supersede this warranty policy. Therefore, we recommend that you review the warranty card supplied with your product at the time of purchase, or contact our distributor in your country for more information and to receive a copy of the warranty policy.**



The CE Mark is a Directive conformity mark of the European Union.

## **For customers in USA**

### **STATEMENT OF FCC COMPLIANCE**

This device complies with Part 15 of the FCC Rules. Operation is subject to the following two conditions: (1) This device may not cause harmful interference, and (2) this device must accept any interference received, including interference that may cause undesired operation. Changes or modifications not approved by the party responsible for compliance could void the user's authority to operate the equipment. This equipment has been tested and found to comply with the limits for a Class B digital device, pursuant to part 15 of the FCC Rules. These limits are designed to provide reasonable protection against harmful interference in a residential installation. This equipment generates, uses and can radiate radio frequency energy and, if not installed and used in accordance with the instructions, may cause harmful interference to radio communications. However, there is no guarantee that interference will not occur in a particular installation. If this equipment does cause harmful interference to radio or television reception, which can be determined by turning the equipment off and on, the user is encouraged to try to correct the interference by one or more of the following measures:

- Reorient or relocate the receiving antenna. Increase the separation between the equipment and receiver. Connect the equipment into an outlet on a circuit different from that to which the receiver is connected.
- \* Consult the dealer or an experienced radio/TV technician for help.

### **For customers in Canada**

This Class B digital apparatus complies with Canadian ICES-003.

### **Pour les utilisateurs au Canada**

Cet appareil numérique de la classe B est conforme à la norme NMB-003 du Canada.

### **FOR CALIFORNIA, U.S.A. ONLY**

Perchlorate Material-special handling may apply. The lithium battery used in this camera contains perchlorate material, which may require special handling.

See [www.dtsc.ca.gov/hazardouswaste/perchlorate](http://www.dtsc.ca.gov/hazardouswaste/perchlorate)

**Declaration of Conformity**  
**According to 47CFR, Parts 2 and 15 for**  
**Class B Personal Computers and Peripherals**  
**We: RICOH IMAGING AMERICAS CORPORATION**  
**Located at: 633 17 Street, Suite 2600, Denver, Colorado 80202, U.S.A.**  
**Phone: 800-877-0155 Fax: 303-790-1131**

Declare under sole responsibility that the product identified herein complies with 47CFR Parts 2 and 15 of the FCC rules as a Class B digital device. Each product marketed is identical to the representative unit tested and found to be compliant with the standards. Records maintained continue to reflect the equipment being produced can be expected to be within the variation accepted, due to quantity production and testing on the statistical basis as required by 47CFR §2.909. Operation is subject to the following two conditions: (1) This device may not cause harmful interference, and (2) This device must accept any interference received, including interference that may cause undesired operation. The above named party is responsible for ensuring that the equipment complies with the standards of 47CFR §15.101 to §15.109.

**Product Name: Digital Camera**  
**Model Number: PENTAX XG-1**  
**Contact person: Customer Service Manager**  
**Date and Place: August, 2014, Colorado**

## Information for Users on Collection and Disposal of Old Equipment and Used Batteries



### 1. In the European Union

These symbols on the products, packaging and/or accompanying documents mean that used electrical and electronic equipment and batteries should not be mixed with general household waste.

Used electrical/electronic equipment and batteries must be treated separately and in accordance with legislation that requires proper treatment, recovery and recycling of these products.



By disposing of these products correctly you will help ensure that the waste undergoes the necessary treatment, recovery and recycling and thus prevent potential negative effects on the environment and human health which could otherwise arise due to inappropriate waste handling.

If a chemical symbol is added beneath the symbol shown above, in accordance with the Battery Directive, this indicates that a heavy metal (Hg = Mercury, Cd = Cadmium, Pb = Lead) is present in the battery at a concentration above an applicable threshold specified in the Battery Directive.

For more information about collection and recycling of used products, please contact your local authorities, your waste disposal service or the point of sale where you purchased the products.

### 2. In other countries outside the EU

These symbols are only valid in the European Union. If you wish to discard used products, please contact your local authorities or dealer and ask for the correct method of disposal.

For Switzerland: Used electrical/electronic equipment can be returned free of charge to the dealer, even when you don't purchase a new product. Further collection facilities are listed on the home page of [www.swico.ch](http://www.swico.ch) or [www.sens.ch](http://www.sens.ch).



**RICOH IMAGING COMPANY,  
LTD.**

2-35-7, Maeno-cho, Itabashi-ku, Tokyo 174-8639, JAPAN  
(<http://www.ricoh-imaging.co.jp>)

**RICOH IMAGING EUROPE  
S.A.S**

112 Quai de Bezons, B.P. 204, 95106 Argenteuil Cedex,  
FRANCE  
(<http://www.ricoh-imaging.fr>)

**RICOH IMAGING  
DEUTSCHLAND GmbH**

Am Kaiserkai 1, 20457 Hamburg, GERMANY  
(<http://www.ricoh-imaging.de>)

**RICOH IMAGING UK LTD.**

PENTAX House, Heron Drive, Langley, Slough, Berks  
SL3 8PN, U.K.  
(<http://www.ricoh-imaging.co.uk>)

**RICOH IMAGING  
AMERICAS CORPORATION**

633 17th Street, Suite 2600, Denver, Colorado 80202,  
U.S.A.  
(<http://www.us.ricoh-imaging.com>)

**RICOH IMAGING CANADA INC.**

5520 Explorer Drive Suite 300, Mississauga, Ontario,  
L4W 5L1, CANADA  
(<http://www.ricoh-imaging.ca>)

**RICOH IMAGING CHINA  
CO., LTD.**

23D, Jun Yao International Plaza, 789 Zhaojiabang  
Road, Xu Hui District, Shanghai, 200032, CHINA  
(<http://www.ricoh-imaging.com.cn>)

**<http://www.ricoh-imaging.co.jp/english>**

• Specifications and external dimensions are subject to change without notice.

54889EN

Copyright © RICOH IMAGING COMPANY, LTD. 2014  
201408